

TOMI

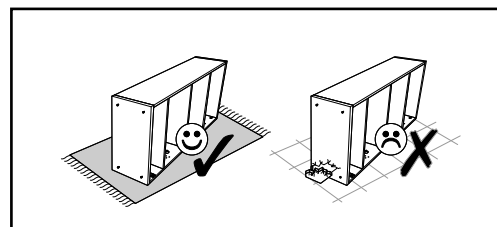

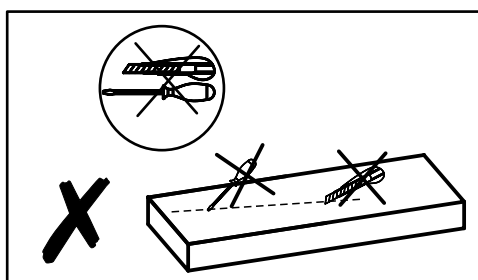

①	1800x420	1	1/2
②	1800x420	1	1/2
③	702x440	1	2/2
④	664x415	5	2/2
⑤	696x60	1	2/2
⑥	696x60	1	2/2
⑦	436x346	1	2/2
⑧	436x346	1	2/2
⑨	688x384	1	2/2
⑩	688x312	3	2/2
⑪	688x434	1	2/2

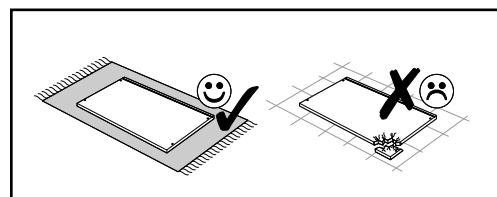
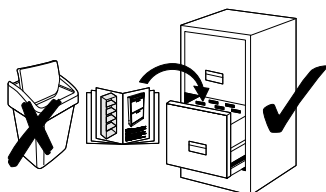
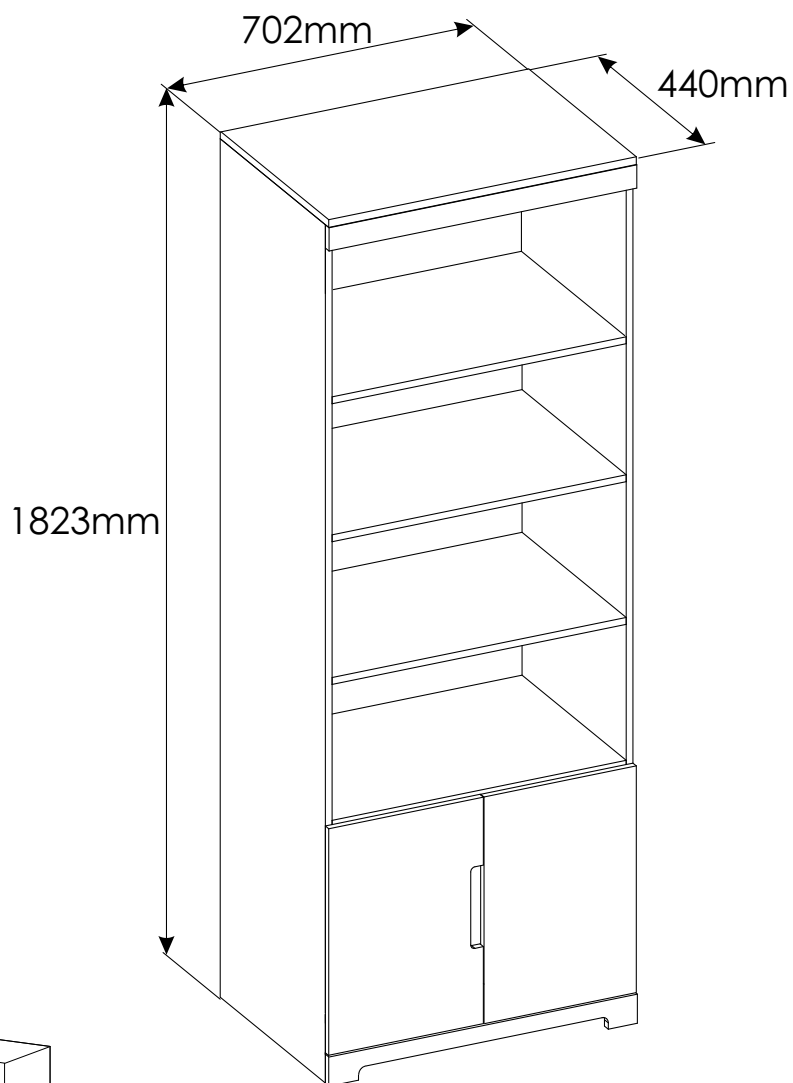
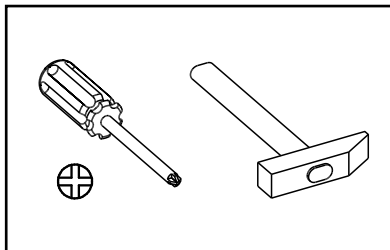
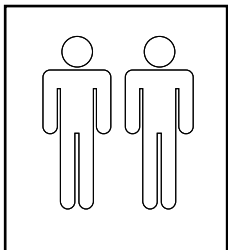
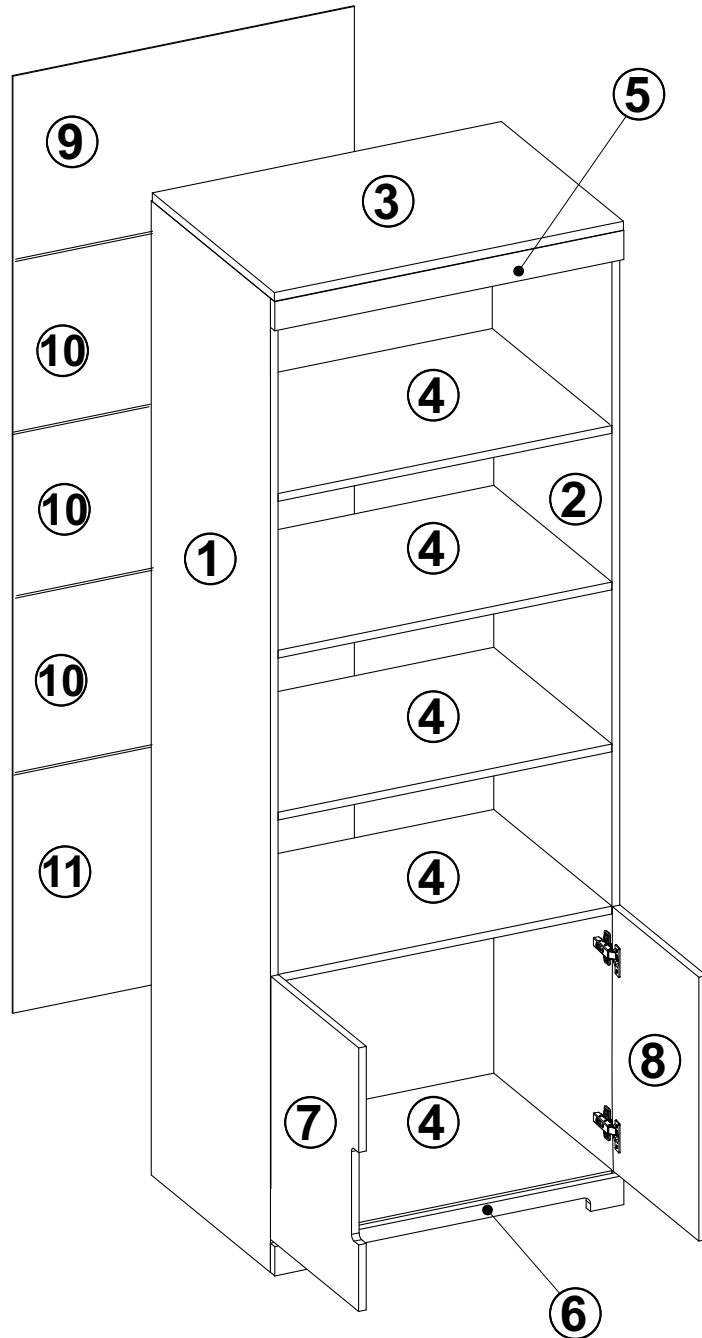
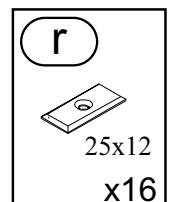
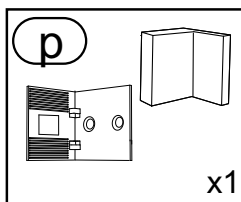
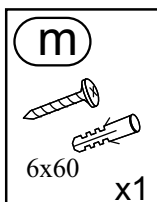
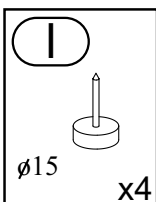
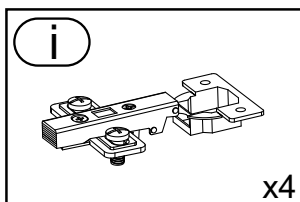
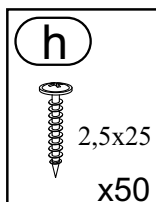
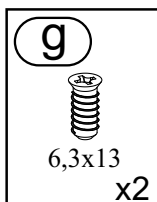
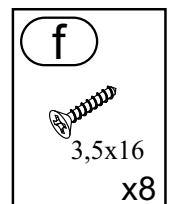
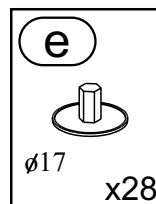
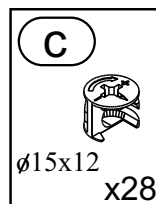
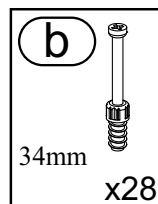
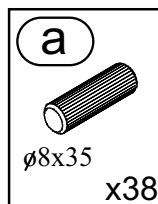

1

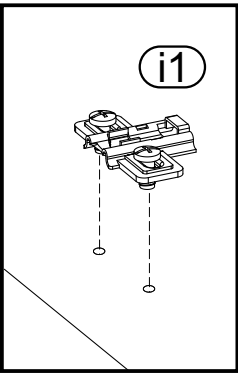
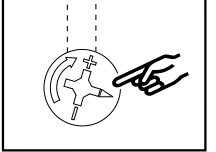
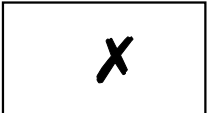
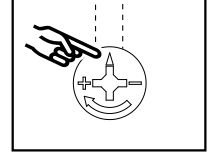
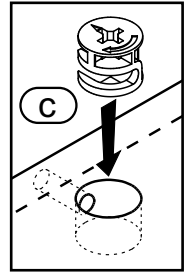
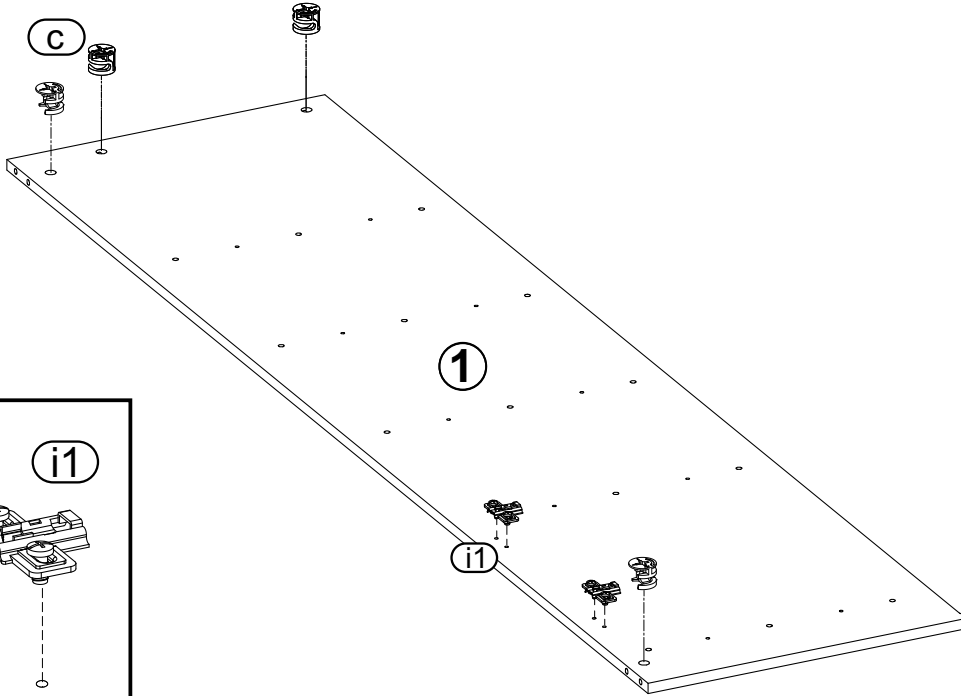
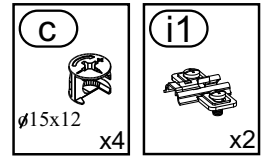
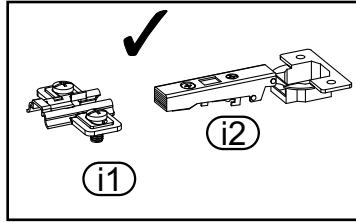
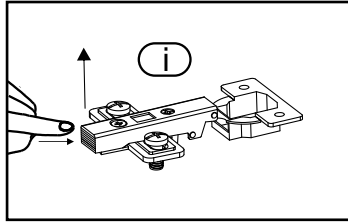

2

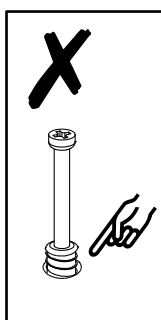
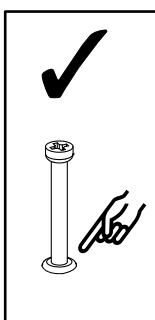
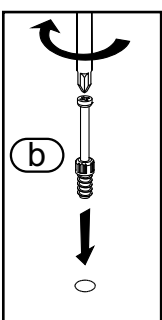
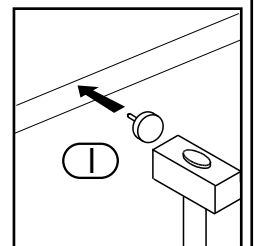
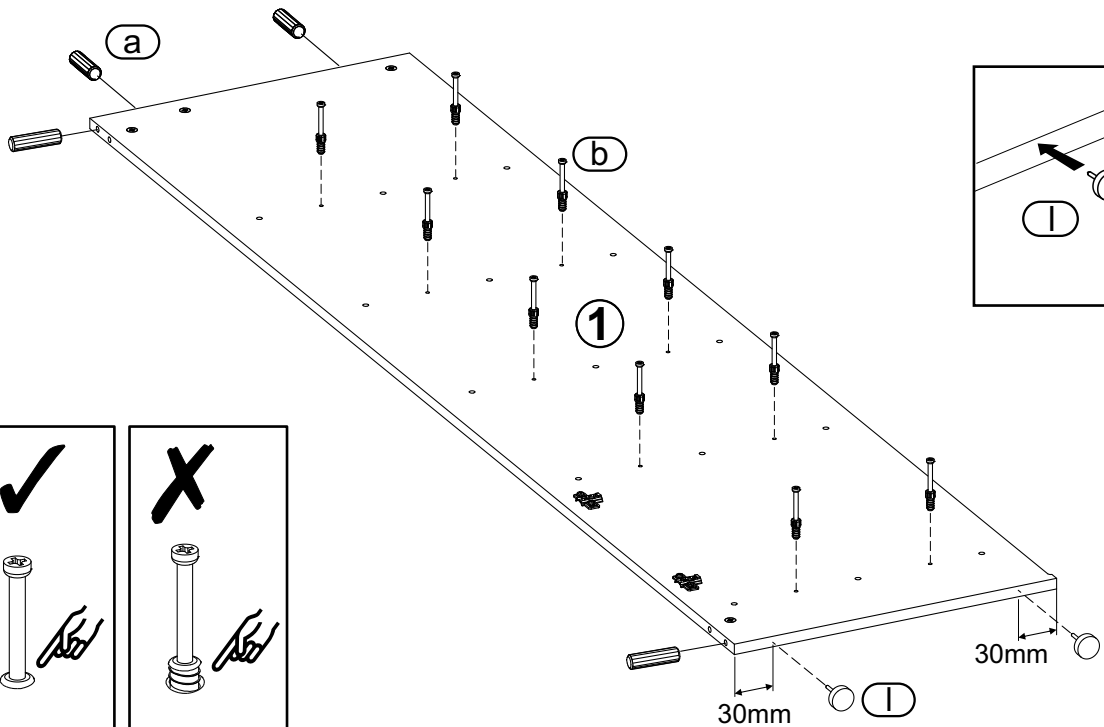
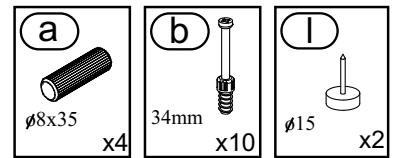
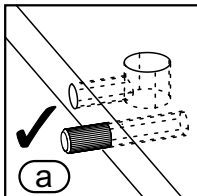
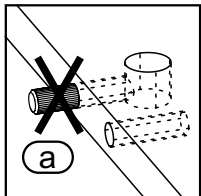
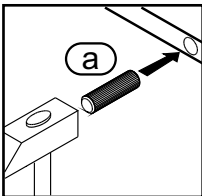

3

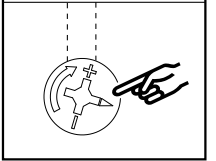
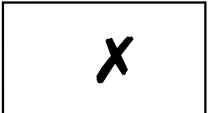
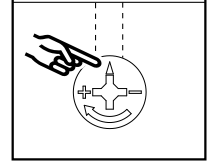
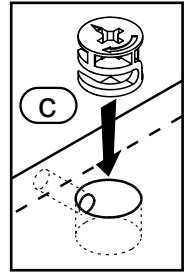
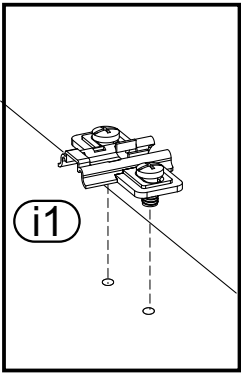
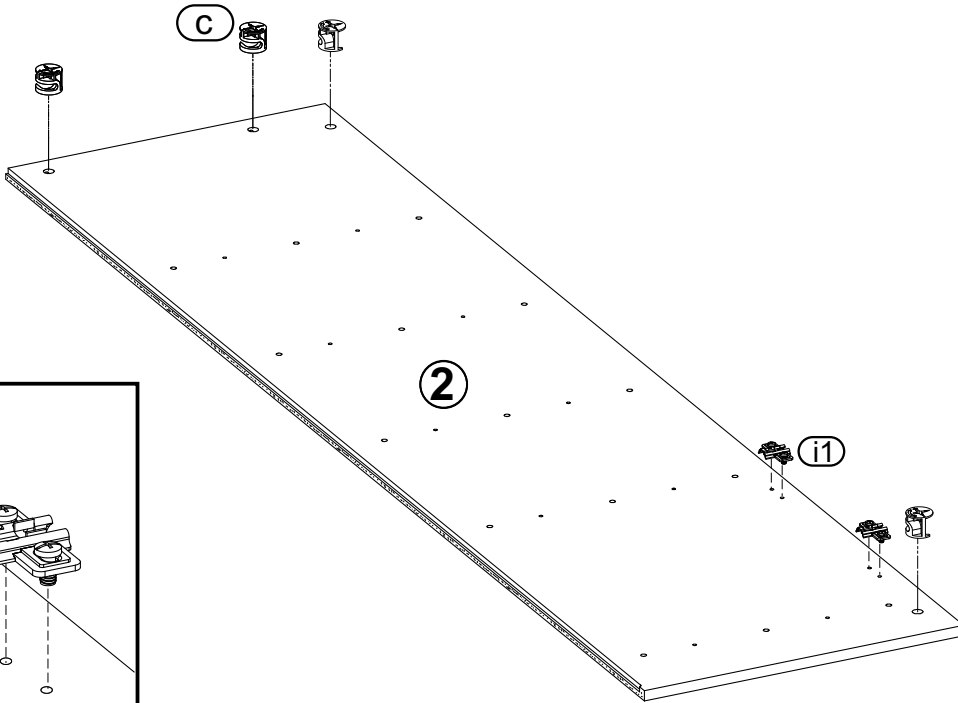
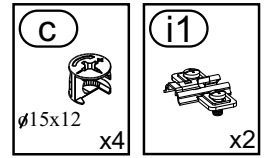
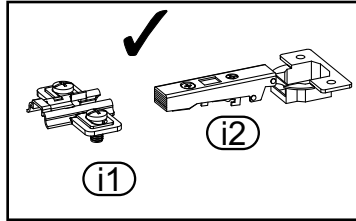
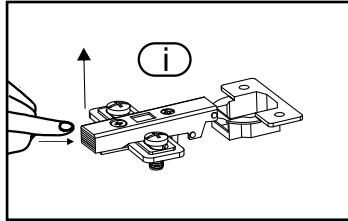

4

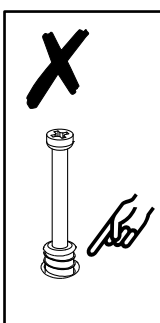
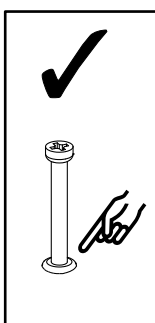
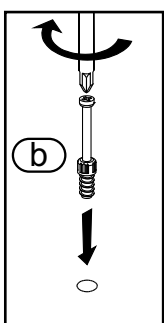
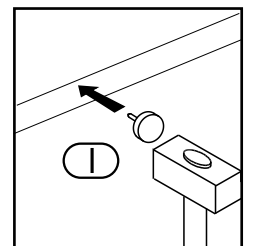
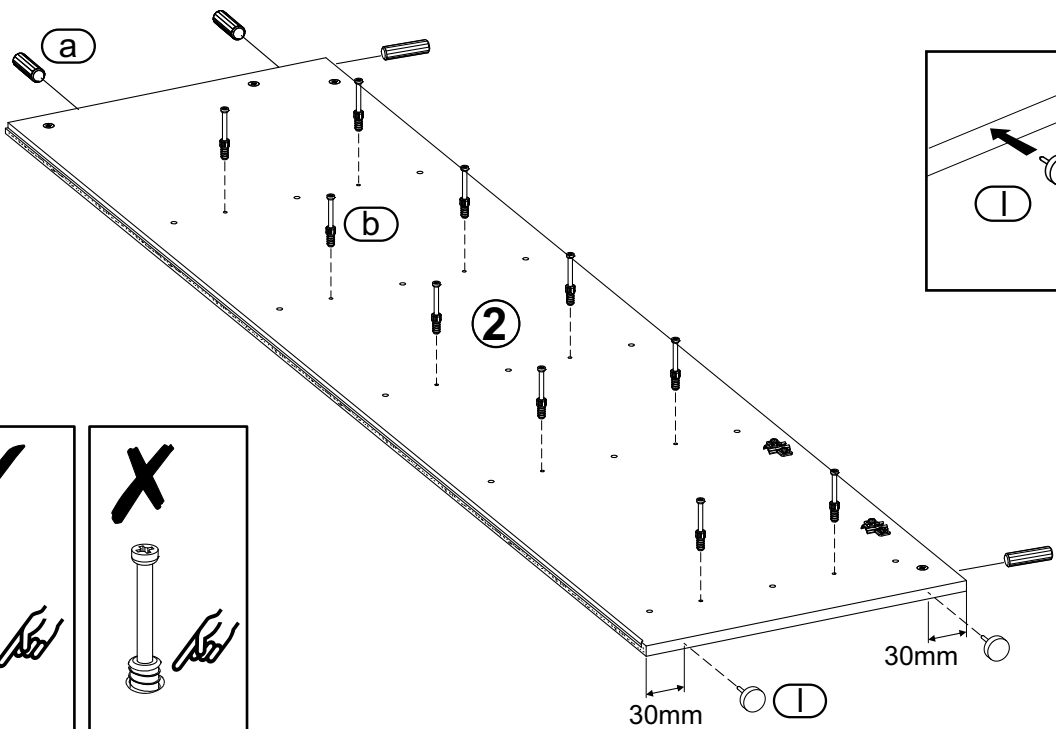
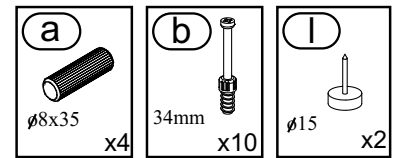
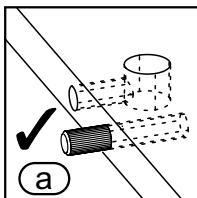
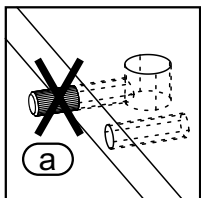
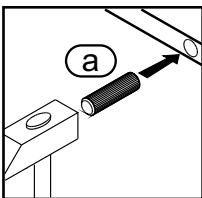

5

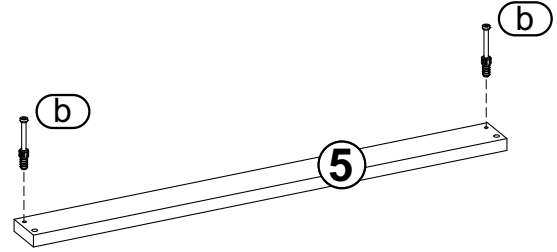
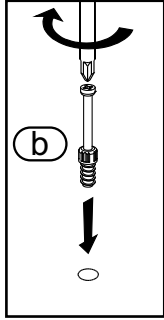
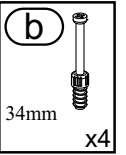
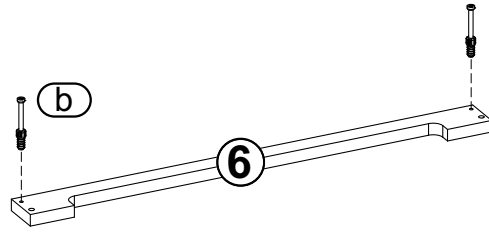

6

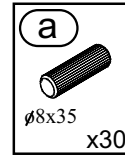
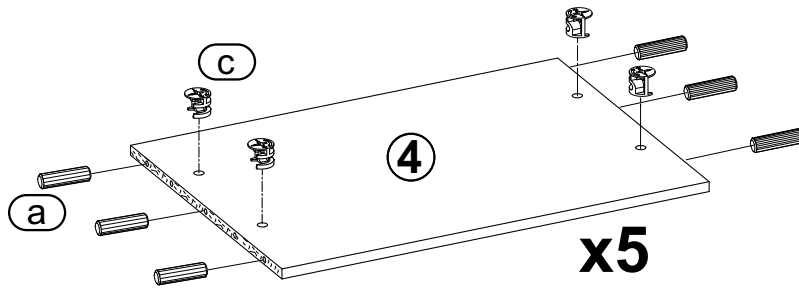

7

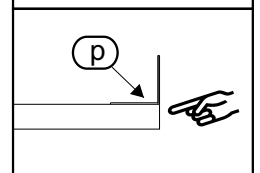
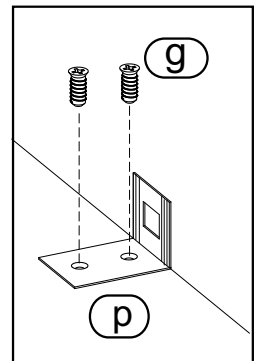
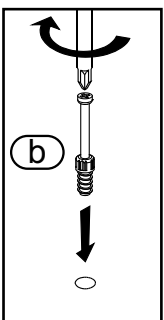
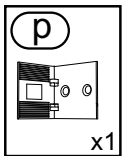
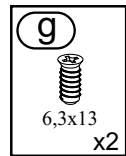
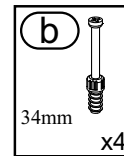
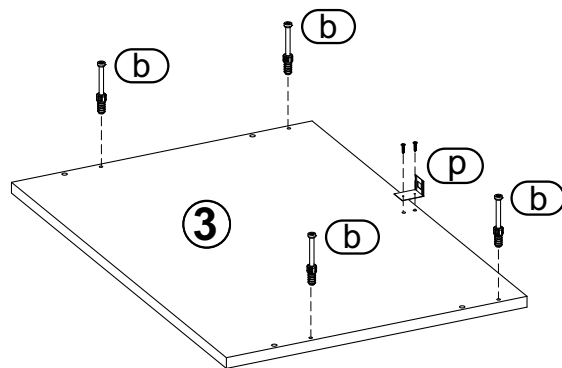

8

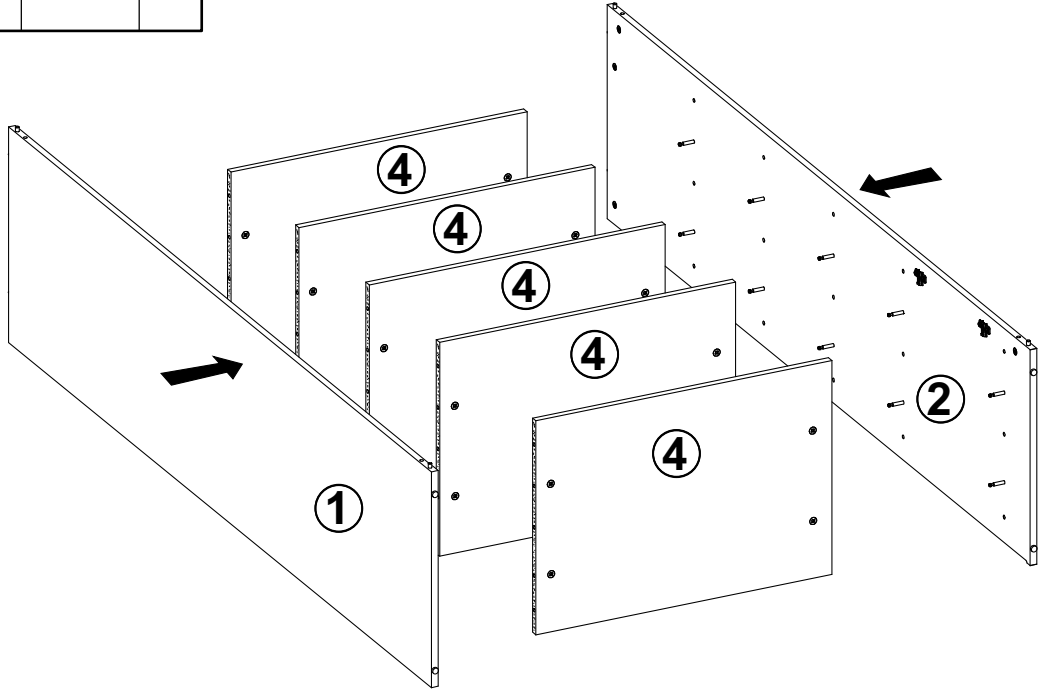
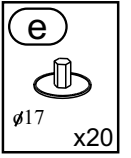
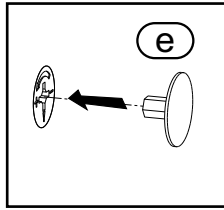
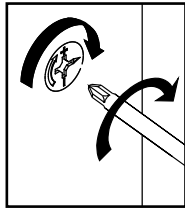
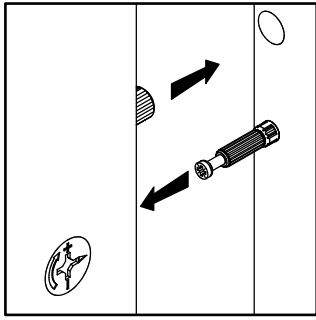

9

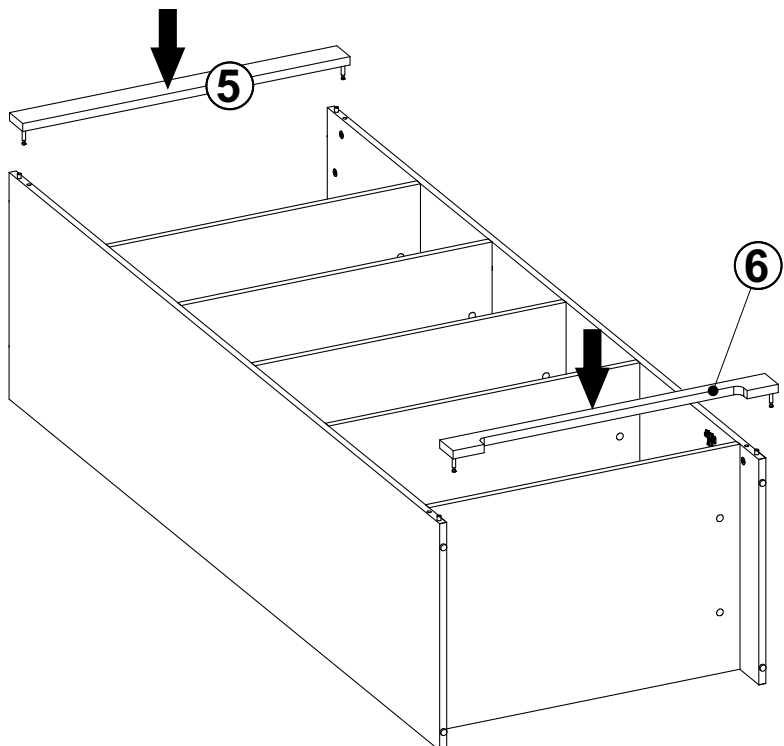
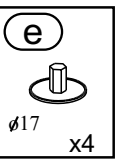
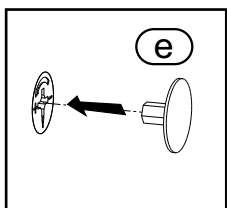
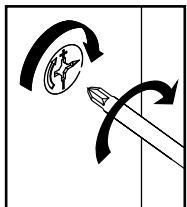
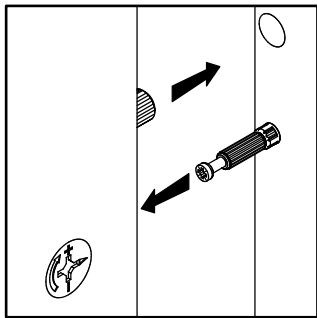

10

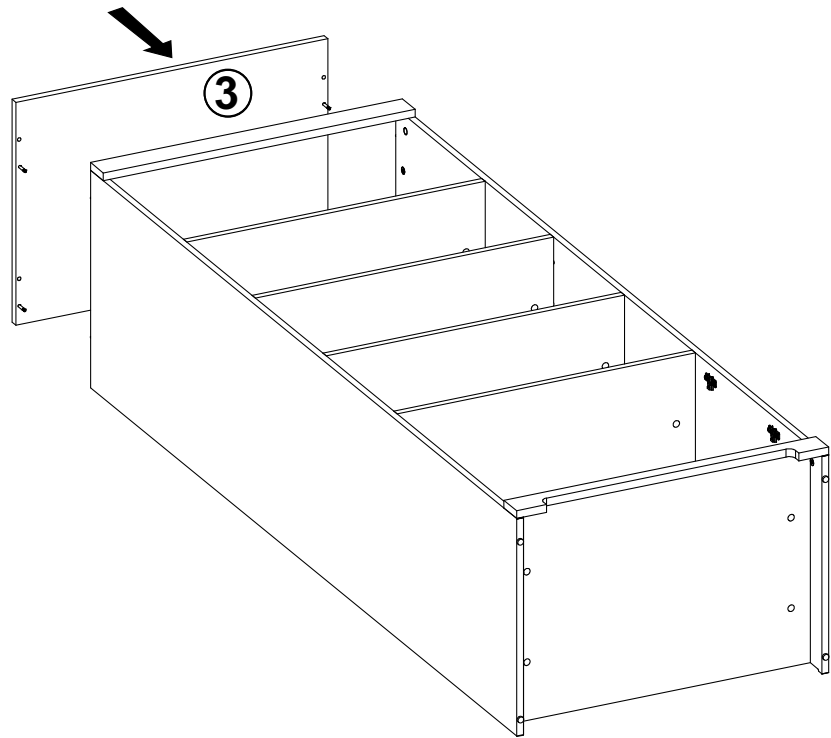
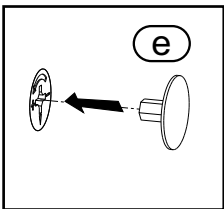
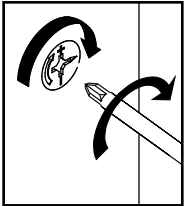
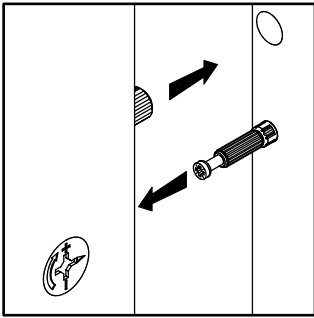
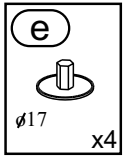

11

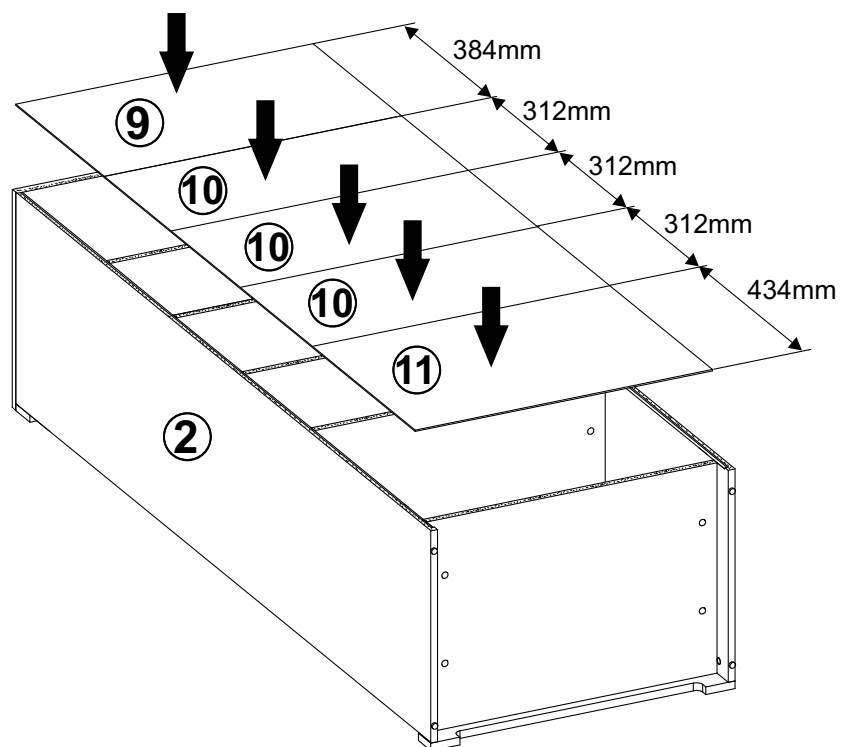
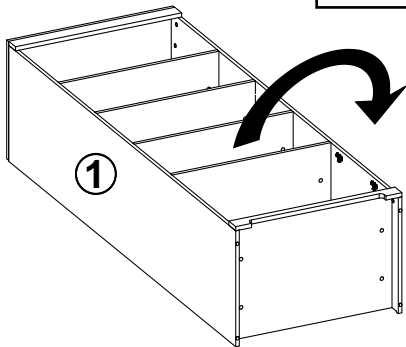
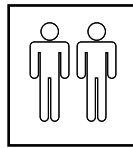

12

A=B

h 2,5x25 x50	r 25x12 x16
---------------------------	--------------------------

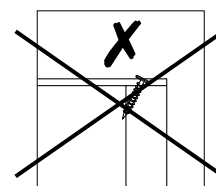
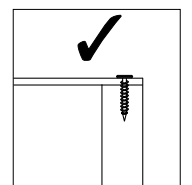
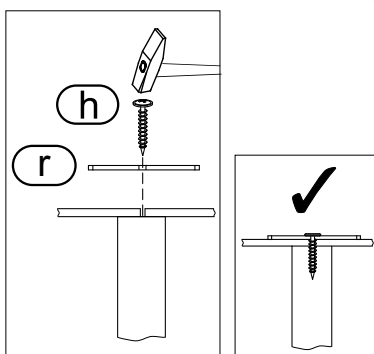
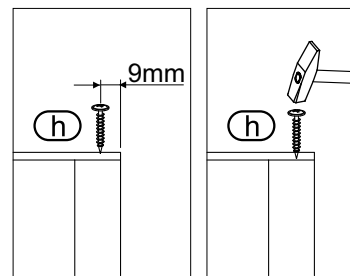
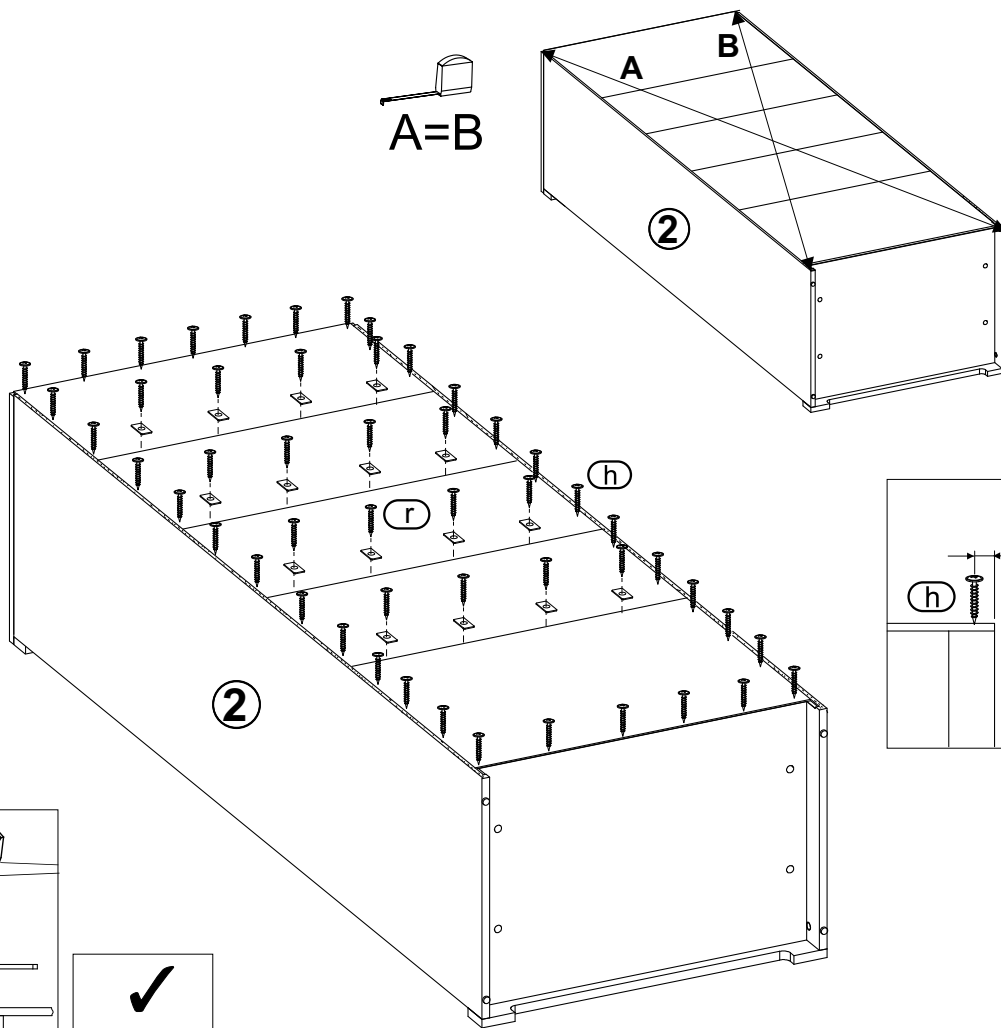

13

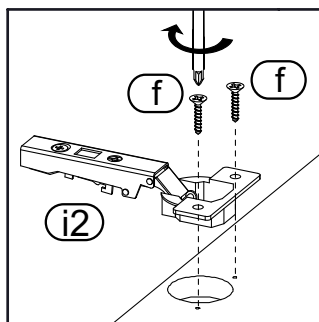

f 3,5x16 x8	i2 x4
--------------------------	-----------------

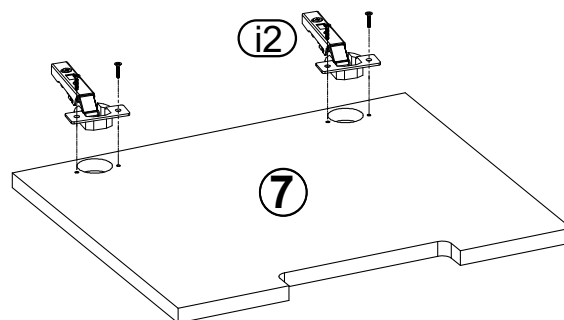
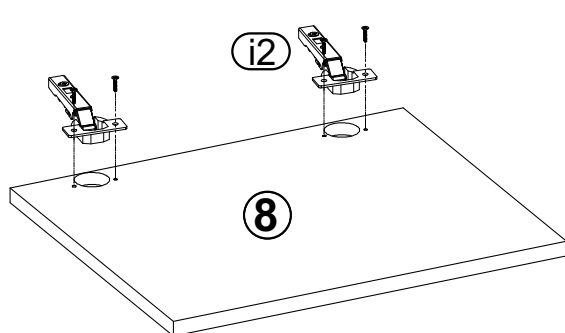

14

